







# FLOWER POWER

d diametro diameter (cm)	peso a vuoto weight empty (Kg)	volume d'acqua water content (dm <sup>3</sup> )	a (cm)	b (cm)	c (cm)	e (cm)	f (cm)	Qs resa termica thermal yield $\Delta t$ 50°C (watt)	Q potenza elettrica electrical power (watt)	versione mista* combined version*	fissa not opening	apribile opening	fissa not opening	apribile opening
														
Ø80	12,0	0,19	32,0	20,0	28,0	40,0	20,0	506	480	•	-	•	-	-
Ø100	19,0	0,30	42,0	20,0	38,0	50,0	30,0	727	720	•	-	•	-	-



\* a richiesta senza sovrapprezzo / upon request without surcharge

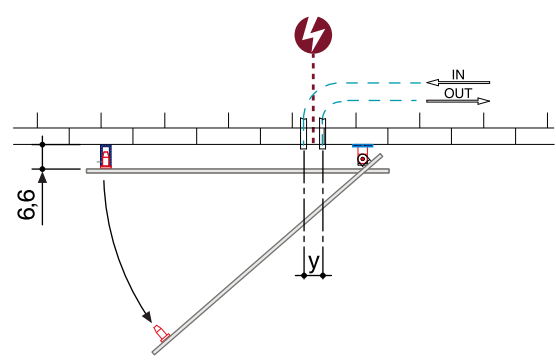
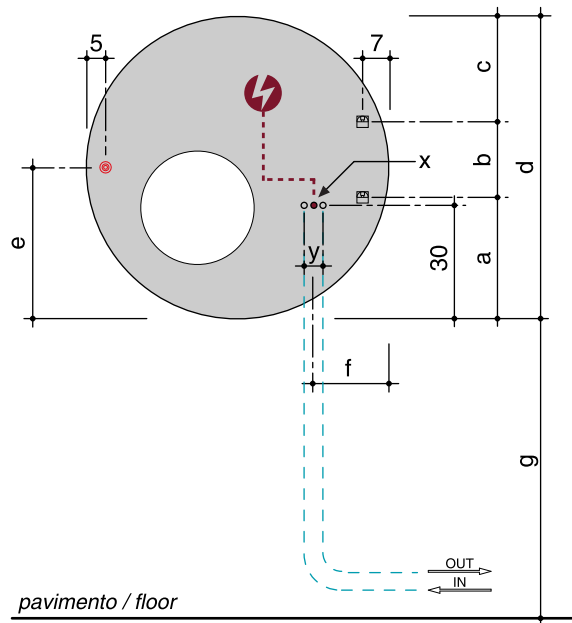

- ~~~~~
- x.* posizione ingresso a muro del cavo (per versione elettrica) / electrical wire wall entry position (for electric version)
  - y.* interasse 5 cm per tubi rame e multistrato; 8 cm per tubi ferro filettato / 5 cm centre to centre distance for copper and multilayer pipes; 8 cm for threaded iron pipes
  - g.* altezza da terra facoltativa (minimo 60 cm) / optional height from the floor (min. 60 cm)